



Instruction Manual

Econo Floss[®]

Model No: 3017-00-000 and 3017-00-010







GOLD MEDAL[®] PRODUCTS CO.



10700 Medallion Drive, Cincinnati, Ohio 45241-4807 USA







SAFETY PRECAUTIONS



	 DANGER
	<p>Machine must be properly grounded to prevent electrical shock to personnel. Failure to do so could result in serious injury, or death. Make sure all machine switches are in the OFF position before plugging the equipment into the receptacle. Keep cord and plug off the ground and away from moisture. Always unplug the equipment before cleaning or servicing. DO NOT immerse any part of this equipment in water. DO NOT use a water jet or excessive water when cleaning.</p> <p style="text-align: right; font-size: small;">008_012221</p>



	 DANGER
	<p>Improper installation, adjustment, alteration, service, or maintenance can cause property damage, injury, or death. Any alterations to this equipment will void the warranty and may cause a dangerous condition. This appliance is not intended to be operated by means of an external timer or separate remote-control system. NEVER make alterations to this equipment. Read the Installation, Operating, and Maintenance Instructions thoroughly before installing, servicing, or operating this equipment.</p> <p style="text-align: right; font-size: small;">014_020416</p>

	 WARNING
	<p>Floss head rotates at high speeds. Operator MUST keep hands and face clear of the floss head to avoid injury. Operator must wear eye protection. Keep all spectators at a reasonable distance, and use a Floss Bubble for added customer protection.</p> <p style="text-align: right; font-size: small;">015_062714</p>





	 WARNING
	<p>Keep all foreign objects out of floss head. To avoid eye injury, DO NOT fill floss head with sugar while the head is on and rotating.</p> <p style="text-align: right; font-size: small;">016_010914</p>

	 WARNING
	<p>Burn Hazard. DO NOT touch spinner head. Allow to cool before cleaning or servicing. Avoid contact with molten sugar.</p> <p style="text-align: right; font-size: small;">006_092414</p>

	 WARNING
	<p>ALWAYS wear safety glasses when servicing this equipment.</p> <p style="text-align: right; font-size: small;">010_010914</p>

	 WARNING
	<p>No user serviceable parts inside. Refer servicing to qualified service personnel.</p> <p style="text-align: right; font-size: small;">011_051514</p>



	<p style="text-align: center;">⚠ WARNING</p> <p>Read and understand operator's manual and all other safety instructions before using this equipment. To order copies of the operator's manual go to gmpopcorn.com or write to Gold Medal Products Co., 10700 Medallion Drive, Cincinnati, OH 45241 USA 1-(800)-543-0862</p> <p style="text-align: right;">022_060215</p>
	<p style="text-align: center;">⚠ WARNING</p> <p>DO NOT allow direct contact of this equipment by the public when used in food service locations. Only personnel trained and experienced in the equipment operation may operate this equipment. Carefully read all instructions before operation.</p> <p style="text-align: right;">012_010914</p>
	<p style="text-align: center;">⚠ WARNING</p> <p>This machine is NOT to be operated by minors.</p> <p style="text-align: right;">007_010914</p>
	<p style="text-align: center;">⚠ CAUTION</p> <p>If the supply cord is damaged, it must be replaced by Gold Medal Products Co., its service agent or similarly qualified persons in order to avoid a hazard.</p> <p style="text-align: right;">039_080614</p>

Note: Improvements are always being made to Gold Medal's equipment. This information may not be the latest available for your purposes. It is critical that you call Gold Medal's Technical Service Department at 1-800-543-0862 for any questions about your machine operations, replacement parts, or any service questions. (Gold Medal Products Co. does not assume any liability for injury due to careless handling and/or reckless operation of this equipment.) General images may be used in manual for reference only.

INSTALLATION INSTRUCTIONS

Inspection of Shipment

After unpacking, check thoroughly for any damage which may have occurred in transit. Claims should be filed immediately with the transportation company. The warranty does not cover damage that occurs in transit, or damage caused by abuse, or consequential damage due to the operation of this machine, since it is beyond our control (reference warranty in back of manual).

Manual

Read and understand the operator's manual and all other safety instructions before using this equipment. To order copies of the operator's manual go to gmpopcorn.com or write to Gold Medal Products Co., 10700 Medallion Drive, Cincinnati, OH 45241 USA 1-(800)-543-0862.

Model Description

3017-00-000: Econo Floss cotton candy machine with aluminum floss pan, Whirlgrip Stabilizer and clips.

3017-00-010: Floss Boss cotton candy machine with non-metal floss pan, Whirlgrip Stabilizer and clips.

Items Included with this Unit



Whirlgrip Floss Stabilizer
(PN 3010)

Aluminum Floss Pan
Model 3017 (000)
(PN 42040)

Non-Metal Floss Pan
Model 3017 (010)
(PN 42040NMR)

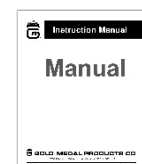

**Instruction
Manual**



**Registration
Warranty Card**



Setup for Use (General reference images shown)



Step 1: Set unit on a level surface. **DO NOT lift unit by spinner head.**

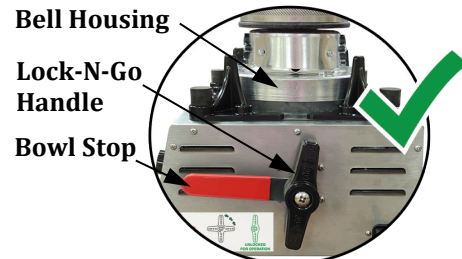
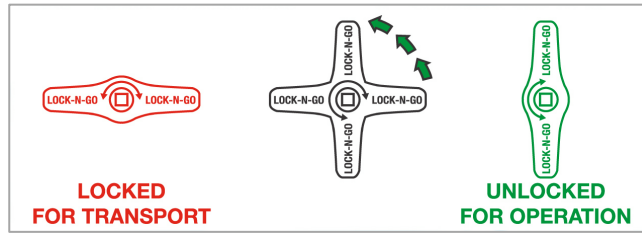

Step 2: Lock-N-Go® handles are used for transport ONLY. Rotate both handles to UNLOCK unit and allow the bell housing to "float" freely on the springs for operation. This also rotates the bowl stop out of the way—the floss bowl will not fit with bowl stop "up". **DO NOT operate with handles in the transport position.**



Step 3: Place floss pan on unit—make sure bowl stop is rotated out of the way.

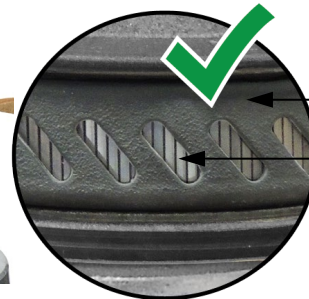

Band
Floss Ribbon shown correctly sitting in band.

Step 4: Check the floss ribbon(s) (heating element) located inside the head assembly; make sure it has not shaken out of the band during transportation. If ribbon is out of band, push it back into place manually, before plugging in machine.



Step 5: Install Floss Stabilizer (see instructions on next page).

Unit should be cleaned prior to use (reference Care and Cleaning section of this manual).



Whirlgrip Floss Stabilizer

Installation Instructions

Unit must be OFF, and cool to install Floss Stabilizer. Place Floss Pan on unit and install Whirl Grip Floss Stabilizer (Item No. 3010) as shown below. Kit includes: Floss Stabilizer/screening (P/N 43032), and (6) Whirlgrip Clips (P/N 77470). Clips are designed to provide air space between screening and floss pan.

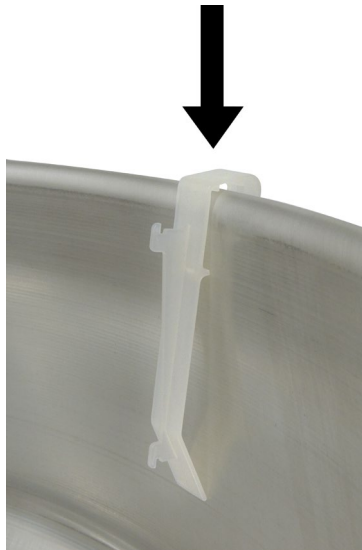

Step 1: Place Whirl Clips over rim of pan with hooks facing inside.

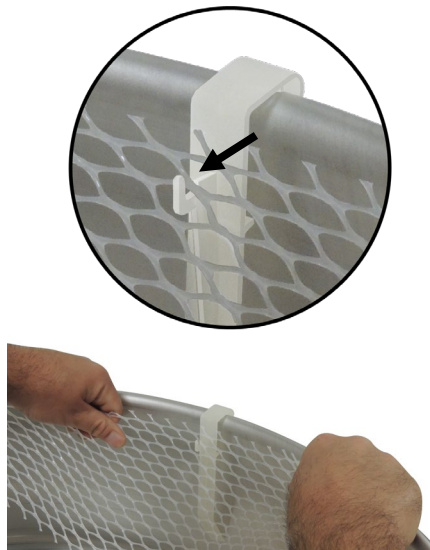

Step 2: Hang Stabilizer on top, up facing hook. Screening should be about flush with top of pan.

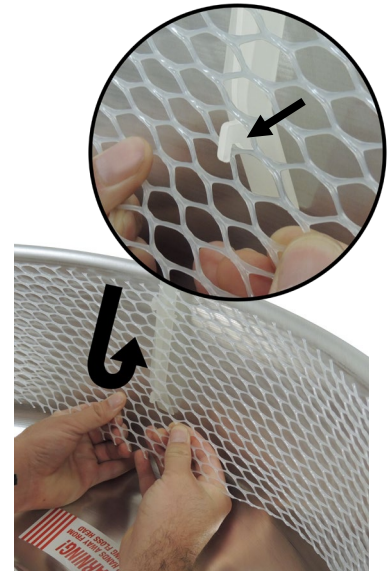

Step 3: Gently pull screening down and attach to bottom, down facing hook.

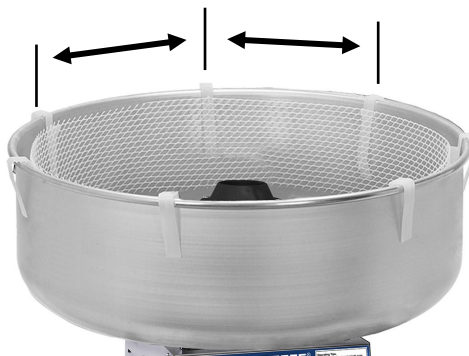

Allow **air space** for proper operation.

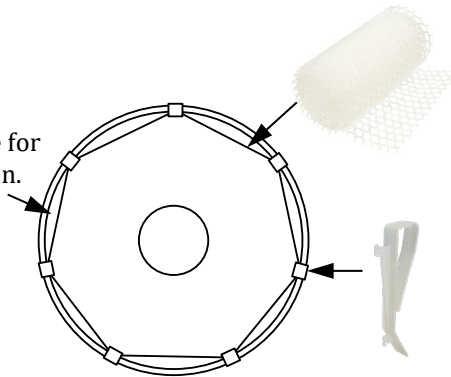

Top View of Floss Pan



Step 4: Repeat for all clips keeping equal spacing around pan (number of clips varies by model). Allow air space between pan and screening for proper operation.



Electrical Requirements

The following power supply must be provided (reference unit Data Plate for Wattage requirement):



120 V~, 60 Hz

	 DANGER
	<p>Machine must be properly grounded to prevent electrical shock to personnel. Failure to do so could result in serious injury, or death. Make sure all machine switches are in the OFF position before plugging the equipment into the receptacle. Keep cord and plug off the ground and away from moisture. Always unplug the equipment before cleaning or servicing. DO NOT immerse any part of this equipment in water. DO NOT use a water jet or excessive water when cleaning.</p> <p style="text-align: right; font-size: small;">008_012221</p>

A certified electrician must furnish sufficient power for proper machine operation and install any supplied receptacle (reference unit Data Plate for model specific Volts AC, Hertz, and Wattage requirements). We recommend this equipment be on a dedicated and protected circuit. Failure to wire properly will void the warranty and may result in damage to the machine. It is Gold Medal Products Co.'s recommendation that this machine be plugged directly into a wall outlet. The use of extension cords is not recommended due to safety concerns, and may cause sacrificed and/or reduced performance. Make sure cord is located to prevent a trip hazard or unit upset.

Before You Plug In Machine

1. Make sure all machine switches are OFF before plugging equipment into receptacle.
2. Make sure wall outlet can accept the grounded plugs (where applicable) on the power supply cord.
3. The wall outlet must have the proper polarity. If in doubt, have a competent electrician inspect the outlet and correct if necessary.
4. **DO NOT** use a grounded to un-grounded receptacle adapter (where applicable).
5. Install unit in a level position.

	 CAUTION
	<p>If the supply cord is damaged, it must be replaced by Gold Medal Products Co., its service agent or similarly qualified persons in order to avoid a hazard.</p> <p style="text-align: right; font-size: small;">039_080614</p>

OPERATING INSTRUCTIONS

Controls and Their Functions

MOTOR & MASTER SWITCH

Two position, lighted rocker switch - turns Motor ON/OFF and supplies power to the Heat Switch. The green light ON indicates there is power to the unit.

HEAT SWITCH

Two position, lighted rocker switch - turns the heating element ON/OFF. The green light ON indicates there is power to the element.

HEAT CONTROL

The Heat Control adjusts the power to the heating element. Turn the knob clockwise to increase power to the heating element; turn counterclockwise to decrease power to the heating element.

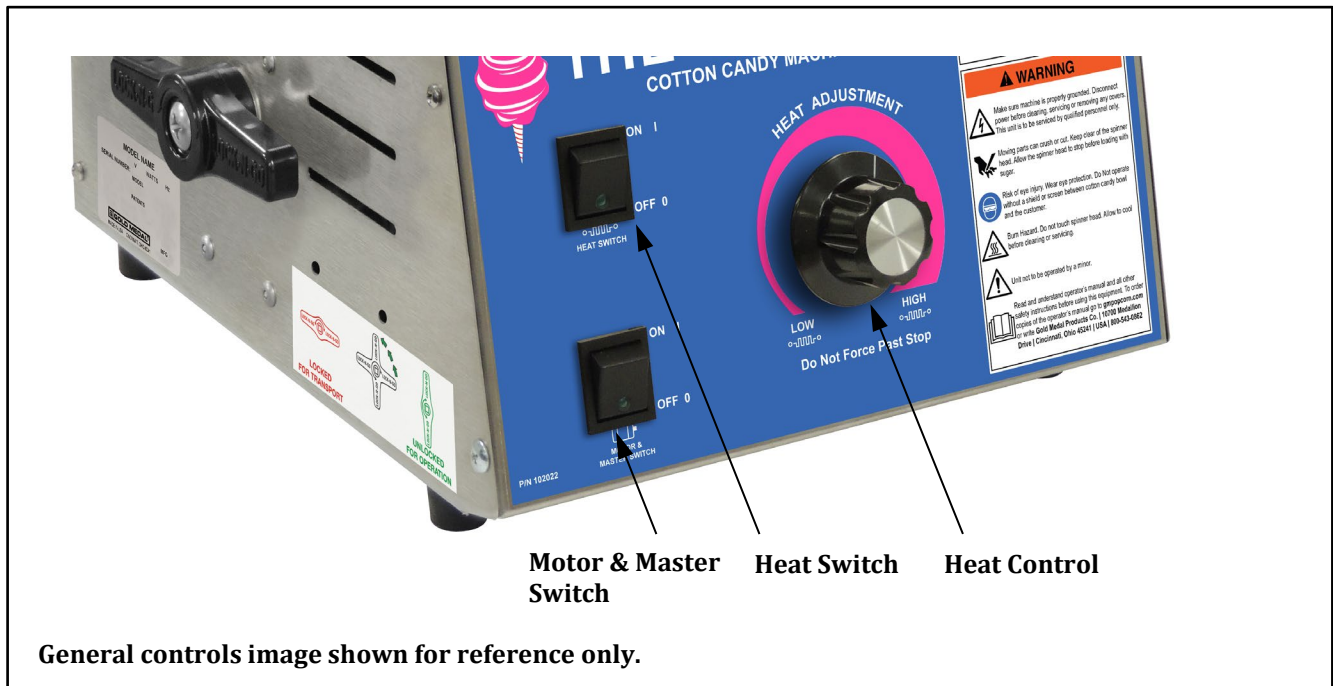



Sugar for Your Candy

Ready to Use Flossugar

Our ready to use Flossugar is the preferred sugar for your new cotton candy machine; however 100% pure cane or beet sugar will do just fine. Our Flossugar gives you good rich colors, and great flavors, too. It is packed in handy half-gallon sealed cartons, with an E-Z pour spout for filling your machine. Flossugar comes in many flavors, and you can easily change flavors for greatest variety, and best sales.

Mix Your Own

If you want to mix your own, use our Flossine[®], and please follow our directions. If you want a deeper color, slightly dampen the mixed sugar. Use a tablespoon of water per five pounds of sugar, sprinkle water over sugar, and mix well. **DO NOT USE EXCESS COLOR!** Too much color will ruin the element on your machine and could create a bitter taste to the candy. There is a limit as to how dark you can make cotton candy. That's because cotton candy is 98% air, and we cannot color the air.

Sugar Considerations

Today 99% of the sugar manufactured is extra fine granulated, which does have some small particles which can slip thru the ribbons without being melted. If this becomes objectionable, you can seek out medium coarse or sanding sugars. The larger crystal size will require a little more heat to melt.

Read the label on the bag of sugar, today we see some free flowing sugars for restaurants. Free flowing sugars contain cornstarch which will burn onto your element/band clogging them rapidly. We have also seen some off-brand sugars that are a blend of sugar and dextrose or corn syrup. This product makes very poor cotton candy. Please make sure you get good sugar for your cotton candy machine.



Machine Operation

Floss Machine Operation

	WARNING
	<p>Floss head rotates at high speeds. Operator MUST keep hands and face clear of the floss head to avoid injury. Operator must wear eye protection. Keep all spectators at a reasonable distance, and use a Floss Bubble for added customer protection.</p> <p style="text-align: right;">015_062714</p>

1. Follow the guidelines described in the Electrical Requirements Section for supplying power to machine.
2. The Heat Switch and the Motor & Master Switch should be in the OFF position.
3. With the spinner head stopped, pour flossugar into the spinner head. Always fill it 90% full with sugar. This 90% level is necessary to obtain a balanced condition in the floss head. **DO NOT OVERFILL!**
IMPORTANT: NEVER add sugar when motor is running.
4. Turn the Motor & Master Switch ON. Wait 10 seconds, and then turn Heat Switch ON.
5. Turn the Heat Control Knob clockwise to maximum setting to initiate the fastest possible warm-up.
6. The machine should start making floss in about 20-30 seconds. When unit starts making floss, **reduce the heat setting**. Turn the Heat Control counter-clockwise to eliminate smoking. If the unit is operated at the “startup” setting it will carbonize the element.

	CAUTION
	<p>Never operate the equipment for a prolonged period of time with the HEAT CONTROL in a position that causes the sugar to smoke. This will result in excessive carbonization of the heat element. If you smell burning sugar or see smoke, reduce the heat.</p> <p style="text-align: right;">030_070914</p>



7. Once the ideal Heat Control setting is found, operate with the setting near this position each time.
8. When the floss head needs to be refilled with sugar, or to stop the machine, turn the Heat Switch OFF and allow the motor to run for a few seconds to start cooling down the floss head, then turn the Motor & Master Switch OFF.

When completing operation for the day (or any prolonged period), follow the instructions in the Shutdown Procedure/Cleaning and Care section of this manual.









Making Floss

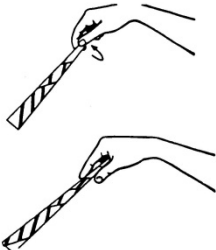

Pick a cone, if it sticks in the stack of cones, twist it off the stack.

	 CAUTION
	<p>Keep hands away from spinning head!</p> <p style="text-align: right; font-size: small;">031_021914</p>

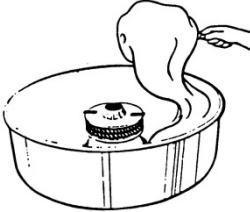
Hold an inch or two of the pointed end of a cone between two fingers and a thumb. With a light flicking action, roll cone in the web of floss building up in the pan. Lift the cone up with the ring of floss attached and rotate the cone to wrap the floss. **DO NOT** roll floss while the cone is inside the pan. This will pack the floss too tightly. See steps 1 thru 8 shown below.

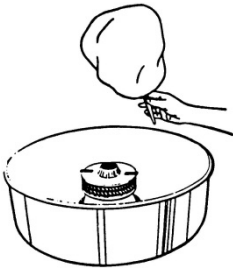
If the floss fails to stick to the cone, pass the cone near the spinner head to pick up a "starter" of melted sugar. Lift the cone out of the pan and wrap the floss with a "figure eight" movement of the hand. This leaves giant pockets and makes the final product appear larger. Make sure room humidity is not too high, or product will be "heavy".

<p>1. Grip cone as shown.</p> 	<p>2. Break into web of floss with the cone.</p> 	<p>3. Wind the sugar onto the cone.</p> 	<p>4. Lift web of floss from the pan and roll onto the cone.</p> 
<p>5.</p> 	<p>6.</p> 	<p>7.</p> 	<p>8.</p> 

	 WARNING
	<ul style="list-style-type: none"> DO NOT PUT HANDS OR OBJECTS IN ROTATING SPINNER HEAD. DO NOT FILL SPINNER HEAD WITH SUGAR WHILE IT IS ROTATING. WEAR EYE PROTECTION. DO NOT PUT HANDS NEAR ROTATING SPINNER HEAD. USE FLOSS CONE TO COLLECT COTTON CANDY. <p style="text-align: right; font-size: small;">032_021914</p>



Floater Adjustments

In operation, the floss will collect on the FLOSS STABILIZER. If the floss collects “low” on the stabilizer, twist the front (leading) edge of the leather floaters down. You get more lift and the floss will collect higher.

Form leather floaters as shown below. This creates a lifting action to float the floss higher on the wall of the floss pan.

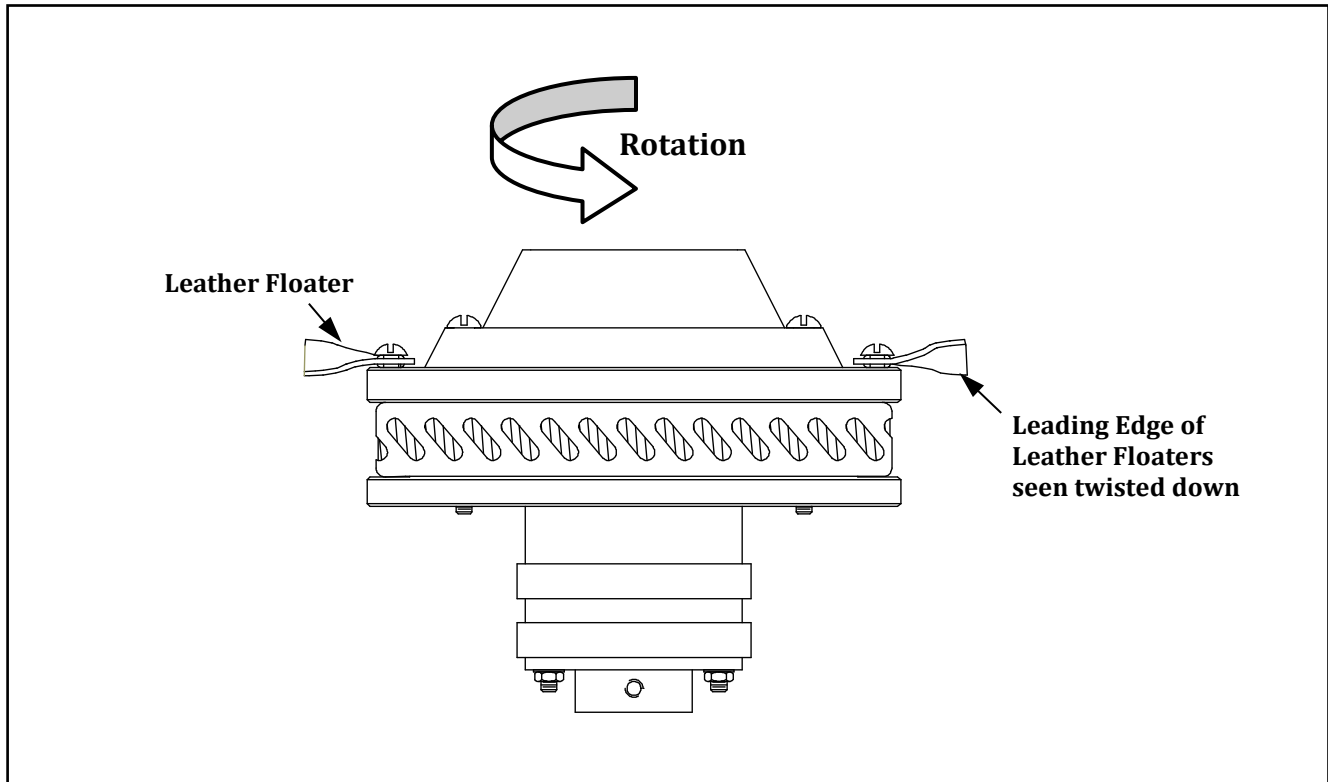



Shut Down Procedure/ Care and Cleaning

Shut Down Procedure

1. When completing operation for the day (or any prolonged period), run the floss head completely empty of sugar.
2. Turn the Heat Control dial to the maximum position, and allow the machine to run approximately 3-4 minutes. This will burn any excess sugar out of the floss head, and prevent any excess carbon build-up.
3. Turn the Heat Switch OFF and allow the motor to run for 1-2 minutes to “cool down” the floss head.
4. Turn the Motor & Master Switch OFF and allow the motor to come to a COMPLETE stop.
5. **NEVER put water in the floss head.**

Care and Cleaning

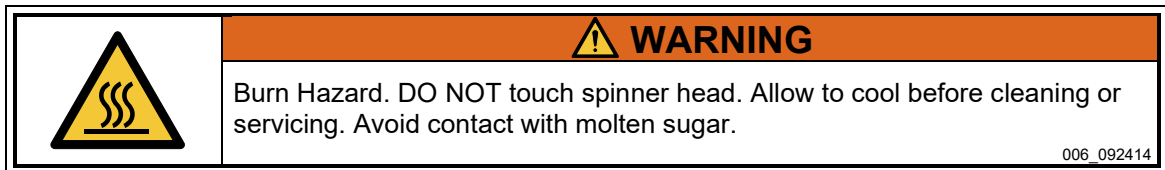

Good sanitation practice demands that all food preparation equipment be cleaned regularly (only use non-toxic, food grade cleaners). A clean looking, well-kept machine is one of the best ways of advertising your product.

Follow the directions below to clean and sanitize the unit each day after use.

1. Unplug the machine and wait for the floss head to cool down to room temperature.
2. Make sure to clean all pans/accessories in order to sanitize them before each use.
3. Wipe all surfaces with a clean, damp cloth.
4. Wipe the stainless steel parts with a clean cloth and cleaner designed for stainless steel, such as Gold Medal Watchdog Stainless Cleaner (Item No. 2088).

DO NOT use oven cleaners or abrasive materials as they will damage parts of machine.



Floss Bands and Ribbons

Gold Medal Floss Bands are designed to give long life and trouble-free service with little care. **DO NOT** scratch the band. Gold Medal Floss Ribbons (heat elements) are made of nickel wire with insulation at the terminal point and on the lead wires. They are designed to be as reliable as the bands; however, the ribbons must be handled carefully. **DO NOT** stretch the ribbon or it will not function properly.

Disassembly and Removal of Floss Band

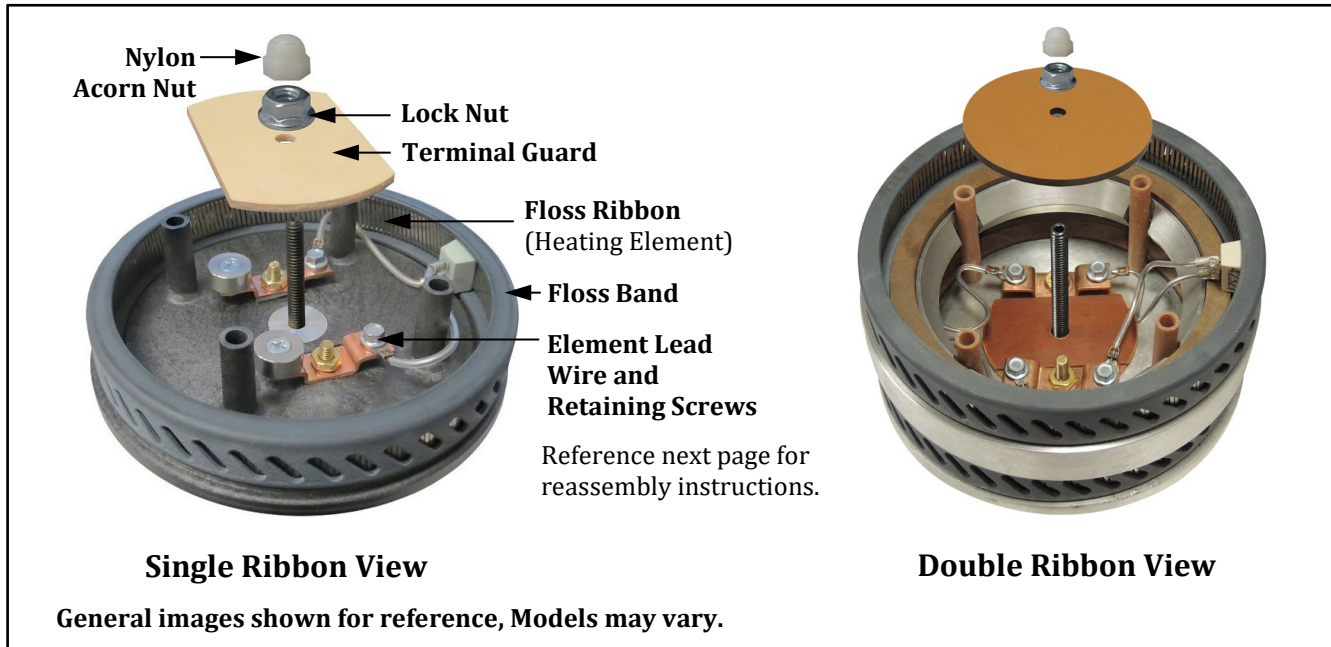

1. Unplug the machine from the power source and allow floss head to cool completely.
2. Remove all sugar from the head of the machine before disassembling. If needed, carefully turn the machine on its side and shake the sugar out.
3. Remove the four spinner cap retainer screws and spinner cap. In some cases, the sugar has caused the cap and band to stick together. Applying gentle pressure with the heel of the hand should free the parts for removal.
4. Remove the nylon acorn nut, lock nut, and terminal guard.
5. Remove the element lead wire retaining screws (using a 1/4" (9.5mm) nut driver), which fasten the element lead wires to the terminals. This will allow the band and ribbon(s) to be removed. **DO NOT PULL OR STRETCH RIBBON(S) TO REMOVE.** (See next page for reconnecting element leads.)
6. If there is excessive sugar buildup, soak the band and ribbon(s) in hot water until the sugar dissolves. When the sugar has been removed, tap the band in the palm of your hand to loosen the ribbon(s) for removal.



7. Inspect, then clean or replace the band and ribbon(s). The primary reason for ribbon replacement is carbon build up inside the ribbon; an additional hot water soak may help remove some of the carbon buildup.
8. When the sugar has been removed, allow the band and element(s) to air dry overnight.

Note: For models with separate heat and motor switches, the best way to dry the floss head after reassembly is to spin it dry for 10 minutes **WITHOUT HEAT** (use motor switch only).

Reassembly of Floss Band – Units with Terminal Assemblies

1. Reinstall band and ribbon(s) on the spinner head; **ALWAYS** attach one ribbon element lead to each terminal assembly (see image below).
2. Reassemble terminal guard, lock nut, and nylon acorn nut.
3. When reinstalling the spinner cap, **DO NOT OVERTIGHTEN SCREWS**. Initially snug down each screw evenly, be careful not to over apply pressure on any single point and crack the band coating. Once snug, tighten all screws evenly to secure spinner cap to floss head.

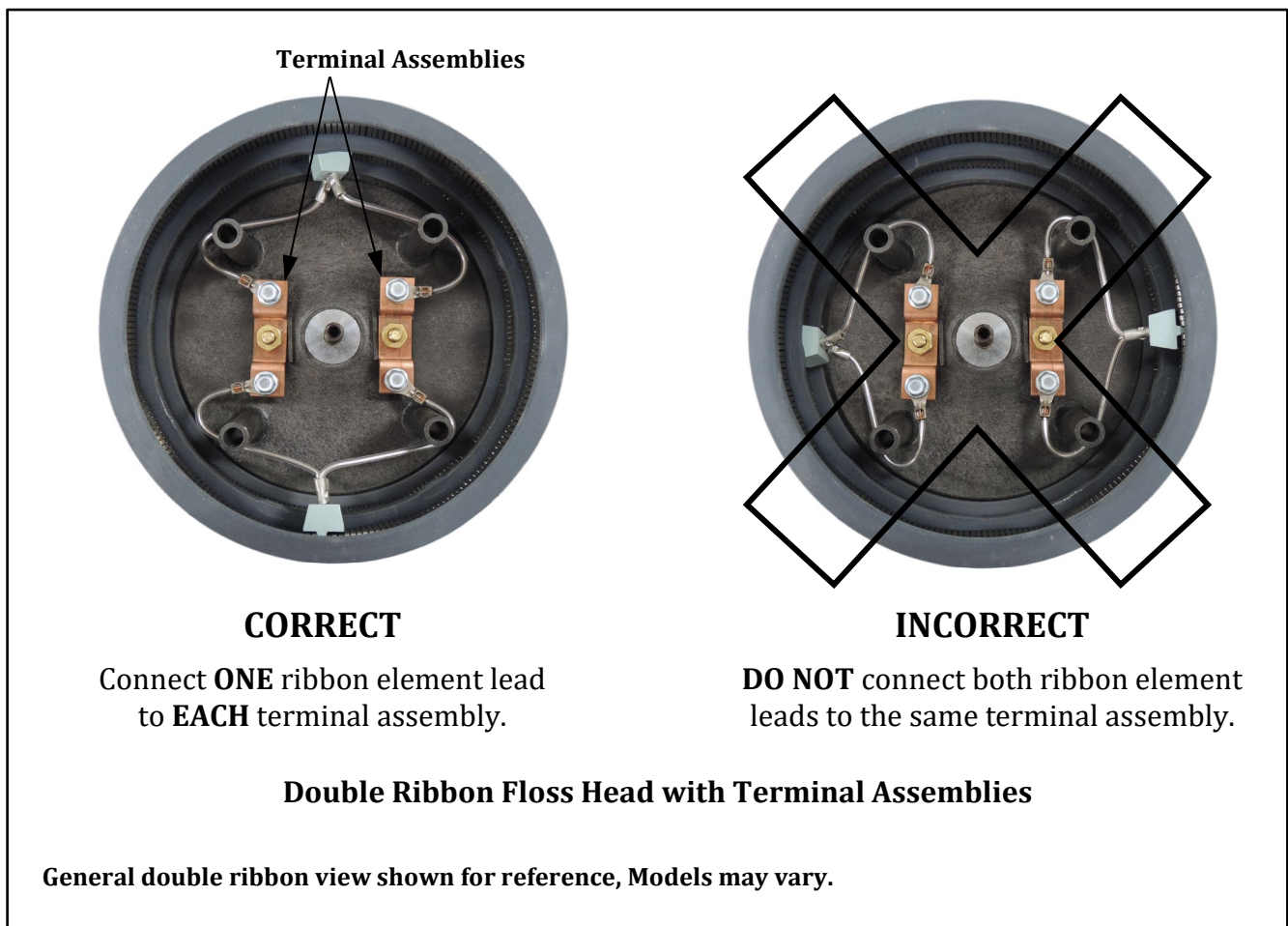



Troubleshooting

Issue	Possible Cause	Solution
Low Production	<p>A. Excessive carbon on the element.</p> <p>B. Heat Control</p> <p>C. Low line voltage.</p> <p>D. Foreign objects in the spinner head.</p>	<p>A. Follow the instructions for removing and cleaning band and element (see Floss Band and Element section).</p> <p>B. Adjust the Heat Control Knob to increase production. If this does not correct the issue, have qualified service personnel check the heat control for correct voltage output. A faulty heat control will need to be replaced by Qualified Service Personnel.</p> <p>C. Check the wall line voltage (where the machine is plugged in), at least 115 VAC is required for the machine to generate floss correctly. A primary reason for low production and poor equipment performance is low line voltage. Have a qualified electrician check the line voltage and add new lines for all the various equipment plugged into the electric circuit if there is not enough current for the requirement listed on the equipment nameplate.</p> <p>The use of extension cords is not recommended due to safety concerns, and may cause sacrificed and/or reduced performance. If the use of an extension cord cannot be avoided then be sure it is no longer than 10 to 12 ft., and is at least 14 AWG wire.</p> <p>D. Foreign objects in the head assembly can short out an element or cause an out-of-balance condition.</p>
Excessive Smoke	<p>A. Heat Control setting.</p> <p>B. Product mixture.</p> <p>C. Excessive sugar buildup.</p>	<p>A. After warm up, equipment should make good floss. Never let the machine operate with the heat so high it produces smoke or you can smell burned sugar. This condition quickly fills the element with carbonized sugar.</p> <p>If adjusting the heat control (and checking the other options listed) does not correct the issue, have Qualified Service Personnel check the heat control.</p> <p>B. Check the product mixture being used. For best results, use nothing with a cornstarch base.</p> <p>C. Check the band for excessive sugar buildup and remove if needed as described in the Floss Band and Element section of this manual.</p>







Issue	Possible Cause	Solution
<p>Excessive Vibration</p>	<p>A. Packing material not removed.</p> <p>B. Lock-N-Go Handles not in operating position.</p> <p>C. Low on sugar.</p> <p>D. Foreign objects or sugar lumps.</p> <p>E. Stretched or uneven suspension springs.</p>	<p>A. If the equipment is new, check that all packing materials were removed from the machine.</p> <p>B. Verify that the Lock-N-Go Handles have been rotated into the operating position.</p> <p>C. Refill the floss head; this will normally eliminate excessive vibration. When adding sugar to the floss head, always fill it 90% full to obtain a balanced condition in the head and eliminate vibration. Do not add sugar with the motor running!</p> <p>D. Run the sugar completely out, then check for foreign objects or sugar lumps in the head assembly.</p> <p>E. If the suspension springs are stretched or uneven this can cause unwanted vibrations. Have Qualified Service Personnel replace if needed.</p>
<p>Lock-N-Go Handles are Hard to Rotate</p>	<p>A. Clamping Cam friction.</p>	<p>A. If handles are hard to move, Qualified Service Personnel may need to apply Petro Gel (Gold Medal Item No. 1110), or a food safe lubricant, to the top surface of the Clamping Cam to reduce friction where the cam contacts the bell housing.</p>







—THE FOLLOWING SECTIONS ARE FOR QUALIFIED SERVICE PERSONNEL ONLY—

MAINTENANCE INSTRUCTIONS

	 DANGER
	<p>Machine must be properly grounded to prevent electrical shock to personnel. Failure to do so could result in serious injury, or death. Make sure all machine switches are in the OFF position before plugging the equipment into the receptacle. Keep cord and plug off the ground and away from moisture. Always unplug the equipment before cleaning or servicing. DO NOT immerse any part of this equipment in water. DO NOT use a water jet or excessive water when cleaning.</p> <p style="text-align: right;">008_012221</p>

	 DANGER
	<p>Improper installation, adjustment, alteration, service, or maintenance can cause property damage, injury, or death. Any alterations to this equipment will void the warranty and may cause a dangerous condition. This appliance is not intended to be operated by means of an external timer or separate remote-control system. NEVER make alterations to this equipment. Read the Installation, Operating, and Maintenance Instructions thoroughly before installing, servicing, or operating this equipment.</p> <p style="text-align: right;">014_020416</p>

	 WARNING
	<p>No user serviceable parts inside. Refer servicing to qualified service personnel.</p> <p style="text-align: right;">011_051514</p>

	 CAUTION
	<p>THE FOLLOWING SECTIONS OF THIS MANUAL ARE INTENDED ONLY FOR QUALIFIED SERVICE PERSONNEL WHO ARE FAMILIAR WITH ELECTRICAL EQUIPMENT. THESE ARE NOT INTENDED FOR THE OPERATOR.</p> <p style="text-align: right;">027_010914</p>



ORDERING SPARE PARTS

1. Identify the needed part by checking it against the photos, illustrations, and/or parts list. (General images may be used in manual for reference only.)
2. Use only approved replacement parts when servicing this unit.
3. When ordering, please include part number, part name, and quantity needed.
4. Please include your model number, serial number, and date of manufacture (located on the machine nameplate/data plate) with your order.
5. Address all parts orders to Parts Department, Gold Medal Products Co., 10700 Medallion Drive, Cincinnati, Ohio 45241-4807

or place orders by phone or online:

Phone: (800) 543-0862
(513) 769-7676

Fax: (800) 542-1496
(513) 769-8500

E-mail: info@gmpopcorn.com
Web Page: gmpopcorn.com



Cabinet Exterior and Lock-N-Go Handle Assembly

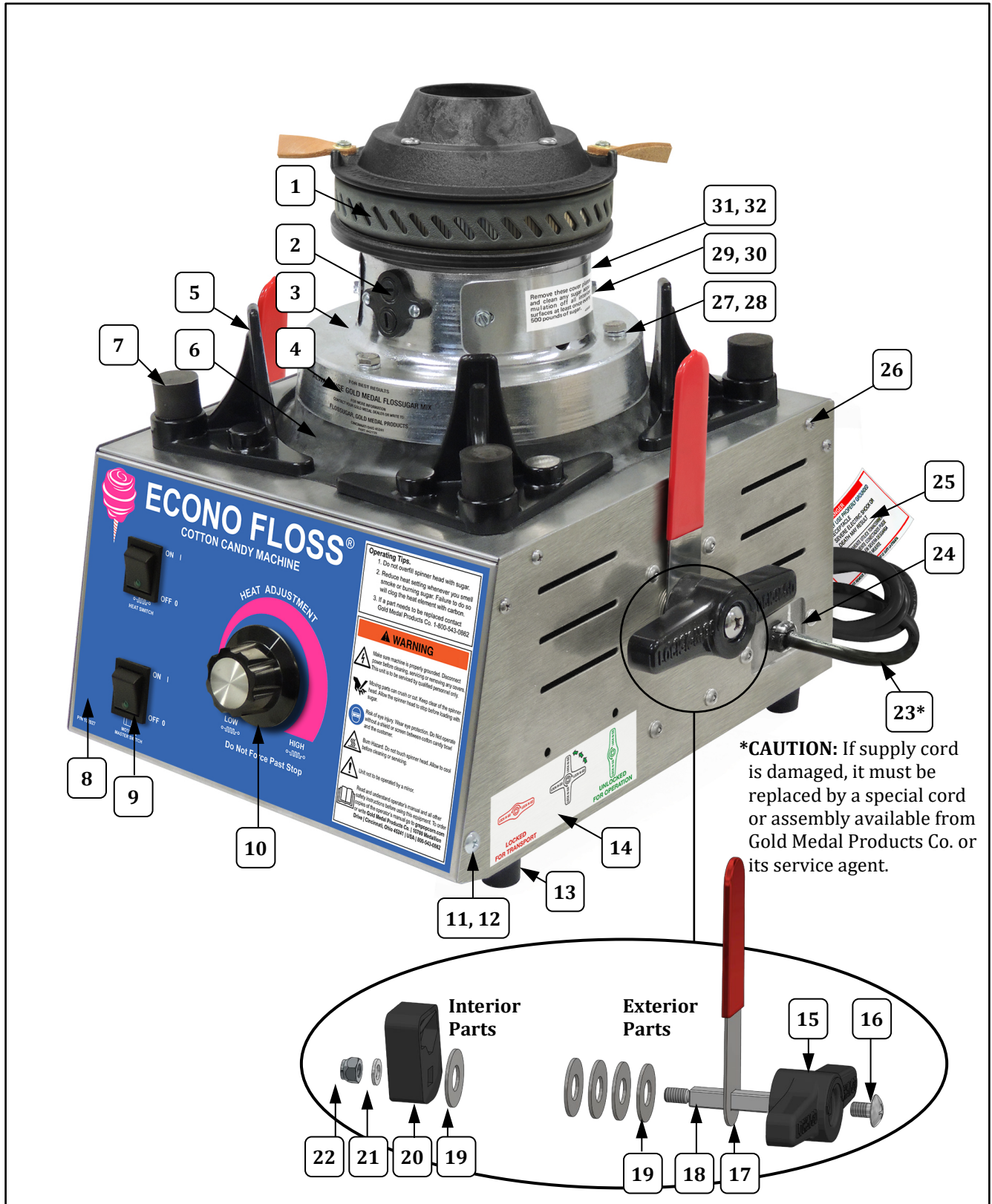

***CAUTION:** If supply cord is damaged, it must be replaced by a special cord or assembly available from Gold Medal Products Co. or its service agent.

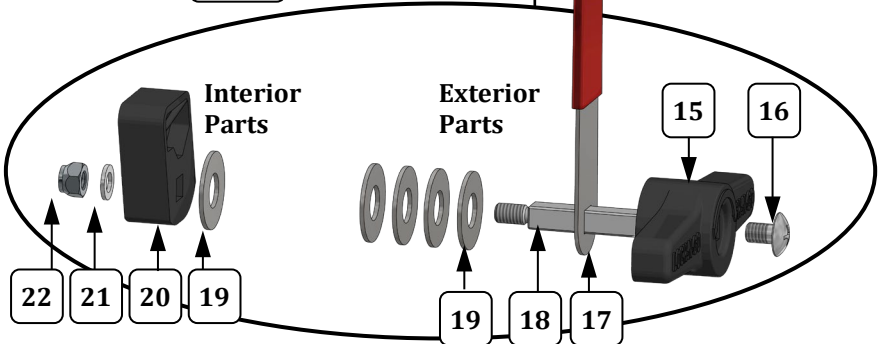



Cabinet Exterior and Lock-N-Go Handle Assembly – Parts List

Item	Part Description	Part Number
		All Models
1	SPINNER HEAD, COMPLETE 5IN (Complete Assy.) See Spinner Head Assembly section for individual parts breakdown.	42283
2	BRUSH HOLDER ASSY (includes Brushes, Caps and Holders) See Brush Assembly Breakdown section for individual parts breakdown.	42382W
3	BELL HOUSING, DUAL BRUSH	42190
4	LABEL,FLOSS ADVERTISEMENT	42159
5	BOWL, SEAL RETAINER	56561
6	BELL HOUSING SEAL	56571
7	THREADED BUMPER,1/4-20	102017
8	NAME,INSTRUCTION OVERLAY	102027
9	SWITCH, LIGHTED ROCKER GR	42798
10	KNOB, HEAT CONTROL	42556
11	10-24 X 1/2 PH TRUSS M/S	42826
12	HEX NUT #10-24 ESLOK	74691
13	RUBBER FEET 3/4IN HIGH (4 required)	47155
14	HANDLE UNLOCK DECAL	102253
15	LOCK N GO HANDLE, NEW CAB.	56563
16	5/16-18 X 1/2 PH TR M/S	12183
17	BOWL STOP SMALL FLOSS	102311
18	CLAMPING SHAFT, LOCK N GO	56565
19	WASHER SS .5 ID X 1.10 OD	48428
20	CLAMPING CAM	42460
21	5/16" NARROW FLAT WASHER	77865
22	HEX NUT 5/16-18 ESLOK	12001
23*	POWER SUPPLY CORD	22038
24	STRAIN RELIEF SR-6P3-4	76026
25	WARNING LABEL CORD	68720
26	8-32 X 3/8 PHIL PAN HEAD	87515
27	1/4-20 X 3/4 GRADE 5 BOLT (w/Lock Washer)	74520
28	TINNERMAN NUT 1/4-20	42125
29	8-32 X 3/8 SLT. HWH M/S	42044
30	#8-32 TINNERMAN FASTENER	47299
31	INSPECTION BRUSH COVER	42381
32	LABEL,CLEAN EVERY 500 LBS	42002



5" Ribbon Spinner Head (Model No. 42283)

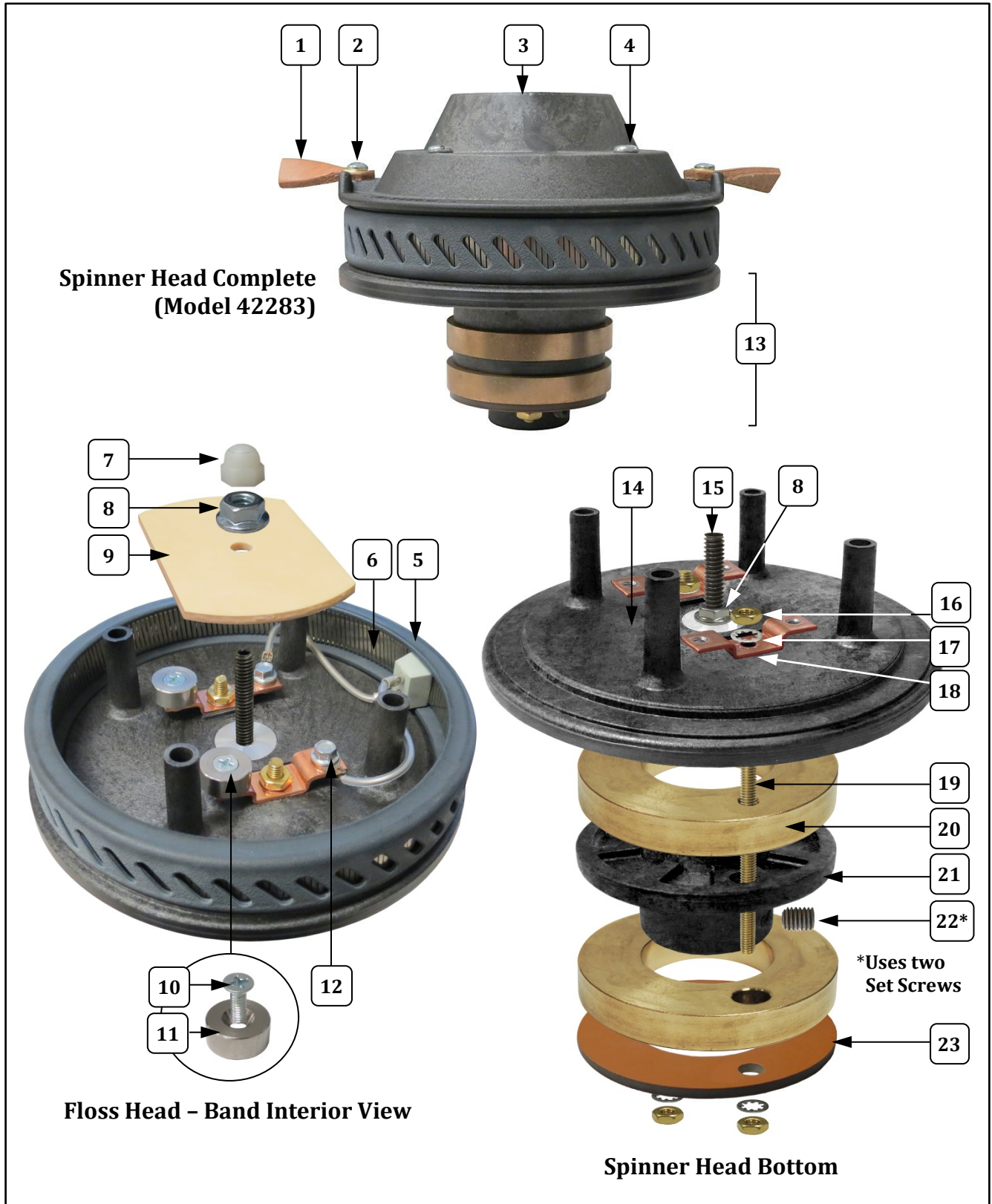



5" Ribbon Spinner Head (Model No. 42283) – Parts List

Item	Part Description	Part Number
		42283
1	LEATHER FLOATER	20010
2	SCREW 8-32 X 5/16 PH PAN MS	89247
3	HIGH CAPACITY SPINNER CAP	43166
4	10-24 X 2 PHIL/SLT MS	42041
5	5 1/2 FLOSS BAND	43165
6	RIBBON REPL, 5 IN 11 OHMS (replacement part includes ribbon 42251 and shipping box)	42279
7	1/4 - 20 NYLON ACORN NUT	48041
8	1/4 - 20 SERRATED LOCK NUT	46311
9	PHENOLIC TERMINAL GUARD	42162
10	8-32X1/2 FL HD PH MS	20066
11	BALANCE WEIGHT	43422
12	8-32 X 1/4 HX HD WHIZ LOCK	42045
13	SPINNER HEAD BOTTOM (Complete assembly includes 2 element lead screws, Terminal Guard, Nylon Nut, Lock Nut, and items listed below.)	42284
14	UPPER SPINNER HEAD	42437
15	1/4-20 X 3 IN SET SCREW	102287
16	HEX NUT #10-32 BRASS	42301
17	#10 INTERNAL TOOTH WASHER	12573
18	TERMINAL ASSEMBLY	42305
19	SLIP RING STUD	42127
20	SLIP RING MACHINED	42126HD
21	LOWER SPINNER HEAD 1/2	42281
22	SET SCREW 1/4-20 X 3/8 (2 required for the Lower Spinner Head)	74125
23	BOTTOM PHENOLIC WASHER	20054



Bell Housing Interior – Brush Assembly

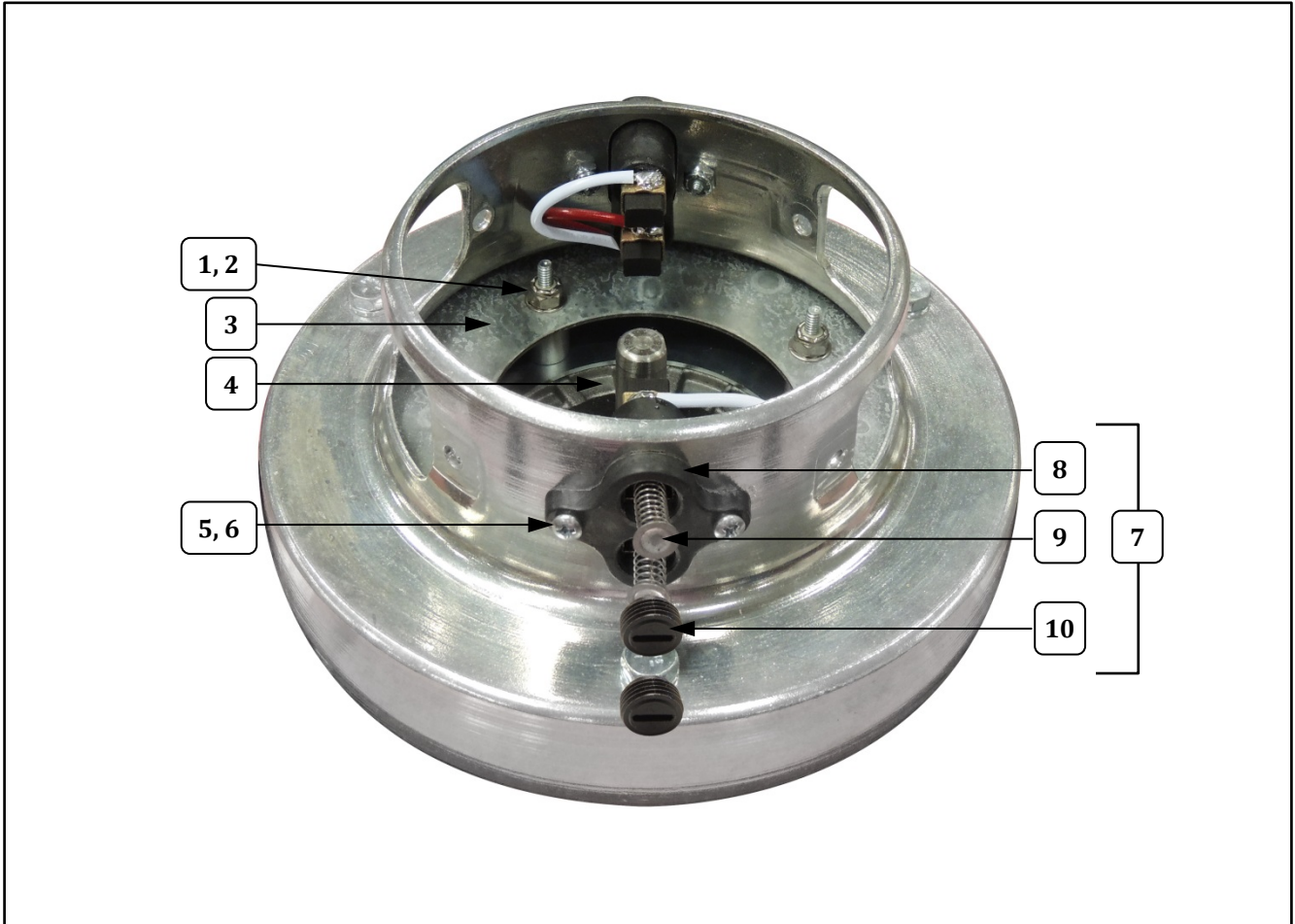

Item	Part Description	Part Number
		All Models
1	HEX NUT #10-24 ESLOK	74691
2	.188ID FLATWASHER	77052
3	MOTOR MTG PLATE	42119
4	MOTOR, FLOSS MACHINE	48649
5	6-32 X 1/2 PH PAN HD M/S	47516
6	6-32 GRIP NUT ZINC PLATED	47517
7	BRUSH HOLDER ASSEMBLY (includes Brushes, Caps and Holders)	42382W
8	DUAL BRUSH HOLDER W/LEADS	42436W
9	CARBON BRUSH	55007
10	CAP, BRUSH HOLDER	42138

Cabinet Interior – Parts Breakdown

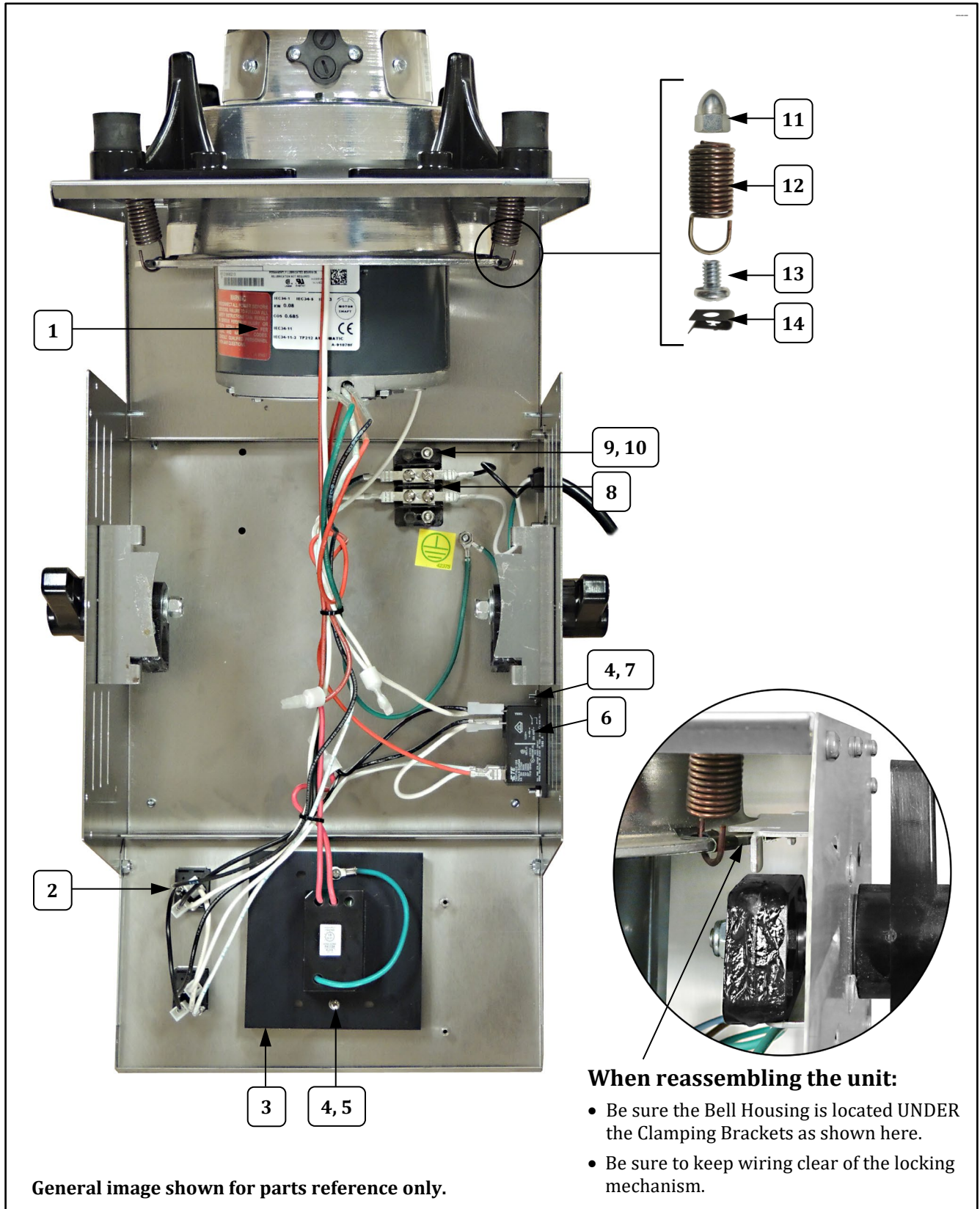

General image shown for parts reference only.



Cabinet Interior - Parts List

Item	Part Description	Part Number
		All Models
1	MOTOR, FLOSS MACHINE	48649
2	SWITCH, LIGHTED ROCKER GR	42798
3	ELECTRONIC HEAT CONTROL	42558
4	6-32 X 3/8 PHIL PAN M/S	39000
5	WASHER #6 INTERNAL TOOTH	76188
6	RELAY, 120VAC, DPST-NO	48590
7	6-32 GRIP NUT ZINC PLATED	47517
8	TERMINAL BLOCK, 2 POS	55620
9	8-32 X 3/4 PHIL PAN MS SS	39007
10	HEX NUT #8-32 STAINLESS	89129
11	ACORN NUT 1/4-20	49068
12	SPRING, SUSPENSION MEDIUM	42524
13	SCREW 1/4-20X3/8 PN HD PH	42360
14	10-24 TINNERMAM FASTENER	42221

Floss Pan and Whirlgrip Stabilizer

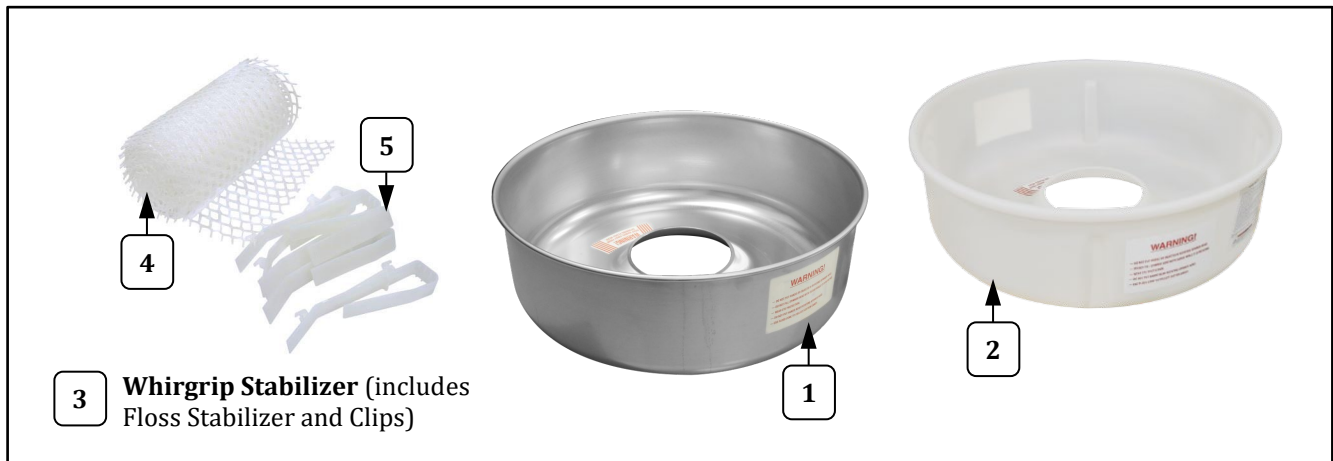

Item	Part Description	Part Number	
		3017-00-000	3017-00-010
1	FLOSS PAN (aluminum)	42040	
2	FLOSS PAN (non-metal)		42040NMR
3	WHIRLGRIP STABILIZER (Includes Floss Stabilizer and Clips)	3010	3010
4	FLOSS STABILIZER (Web)	43032	43032
5	WHIRLGRIP CLIPS	77470	77470



Wiring Diagram

Model No. 3017-00-000 and 3017-00-010

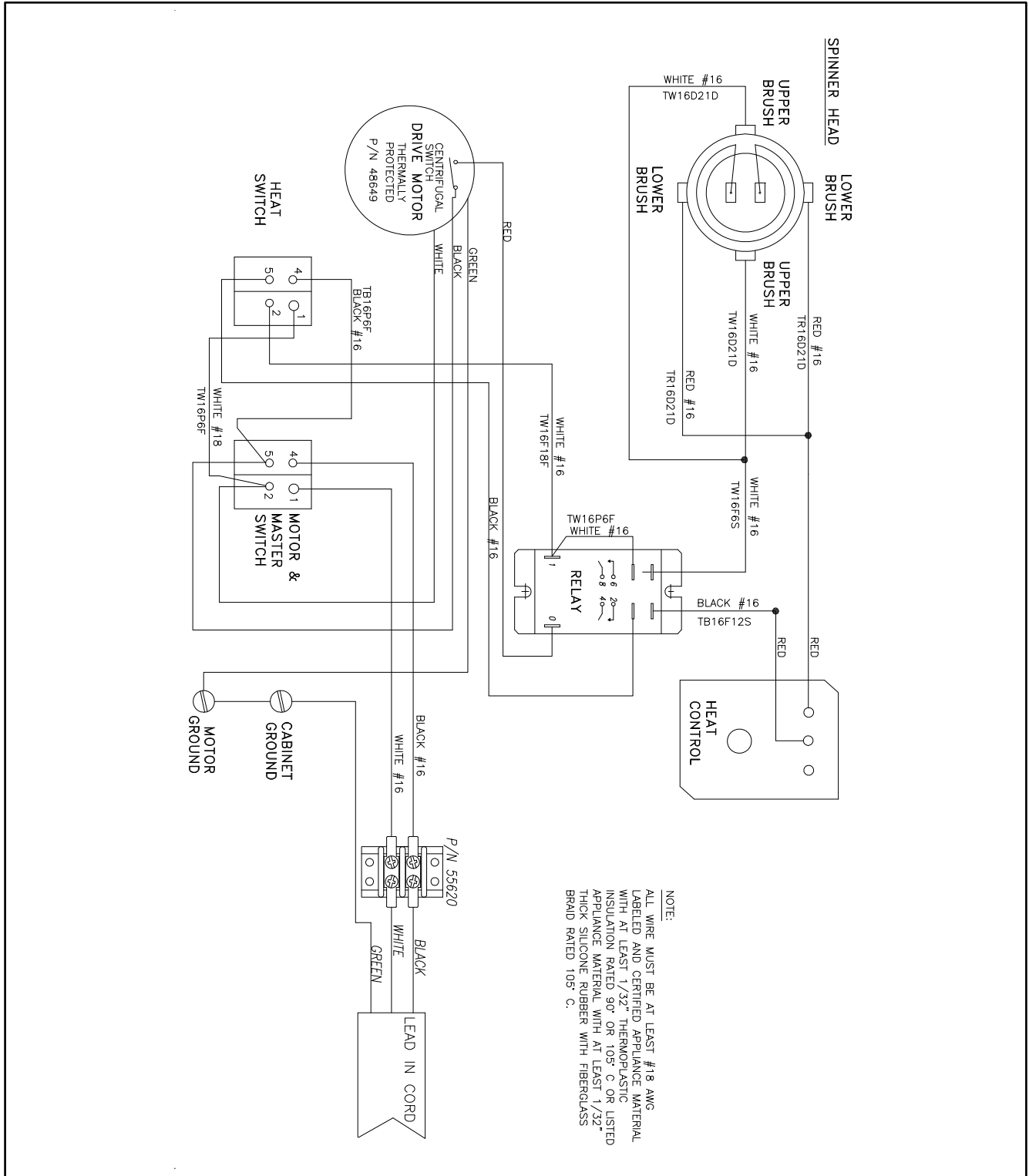



WARRANTY

Gold Medal Products Co. warrants to the original purchaser each item of its manufacture to be free of defects in workmanship and material under normal use and service. Gold Medal Products Co.'s obligation under this warranty is limited solely to repairing or replacing parts, f.o.b. Cincinnati, Ohio, which in its judgment are defective in workmanship or material and which are returned, freight prepaid, to its Cincinnati, Ohio factory or other designated point. Except for "Perishable Parts" on specific machines, the above warranty applies for a period of two (2) years from the date of original sale to the original purchaser of equipment when recommended operating instructions and maintenance procedures have been followed. These are packed with the machine. Parts warranty is two (2) years, labor is six (6) months.

THIS WARRANTY IS IN LIEU OF ALL OTHER WARRANTIES EXPRESSED OR IMPLIED, AND OF ALL OTHER OBLIGATIONS OR LIABILITIES ON OUR PART, INCLUDING THE IMPLIED WARRANTY OF MERCHANTABILITY. THERE ARE NO WARRANTIES WHICH EXTEND BEYOND THE DESCRIPTION ON THE FACE HEREOF. In no event shall Gold Medal Products Co. be liable for special, incidental or consequential damages. No claim under this warranty will be honored if the equipment covered has been misused, neglected, damaged in transit, or has been tampered with or changed in any way. No claim under this warranty shall be honored in the event that components in the unit at the time of the claim were not supplied or approved by Gold Medal Products Co. This warranty is effective only when electrical items have been properly attached to city utility lines only at proper voltages. This warranty is not transferable without the written consent of Gold Medal Products Co.

The term "Original Purchaser" as used in this warranty shall be deemed to mean that person, firm, association, or corporation who was billed by the GOLD MEDAL PRODUCTS CO., or their authorized distributor for the equipment.

THIS WARRANTY HAS NO EFFECT AND IS VOID UNLESS THE ORIGINAL PURCHASER FIRST CALLS GOLD MEDAL PRODUCTS CO. AT 1-800-543-0862 TO DISCUSS WITH OUR SERVICE REPRESENTATIVE THE EQUIPMENT PROBLEM, AND, IF NECESSARY, FOR INSTRUCTIONS CONCERNING THE REPAIR OR REPLACEMENT OF PARTS.

NOTE: This equipment is manufactured and sold for commercial use only.



GOLD MEDAL PRODUCTS CO.

10700 Medallion Drive, Cincinnati, Ohio 45241-4807 USA

gmppopcorn.com

Phone: (800) 543-0862 Fax: (800) 542-1496
(513) 769-7676 (513) 769-8500